



U.S. Patent Nos. 2,675,600, 3,287,530
& 4,464,548

**TEMPERATURE EQUIVALENTS FOR
ORTON STANDARD PYROMETRIC CONES**

Cone No.	Large Cones		Cone No.	Large Cones	
	*108° F	*270° F		*108° F	*270° F
022	1069° F.	1086° F.	06	1816° F	1830° F
021	1116	1137	05	1888	1915
020	1157	1175	04	1922	1940
019	1234	1261	03	1987	2014
018	1285	1323	02	2014	2048
017	1341	1377	01	2043	2079
016	1407	1438	1	2077	2109
015	1454	1479	2	2088	2124
014	1533	1540	3	2106	2134
013	1596	1566	4	2134	2167
012	1591	1623	5	2151	2185
011	1627	1641	6	2194	2232
010	1629	1641	7	2219	2264
09	1679	1693	8	2257	2305
08	1733	1751	9	2300	2336
07	1783	1803	10	2345	2381

*Rate of Heating (Example: 108° F rise per hour)

Notes:

- 1) The rates of heating shown at the head of each column of temperature equivalents were maintained during the last several hundred degrees of temperature rise.
- 2) The temperature equivalents are not necessarily those at which cones will deform under firing conditions different from those under which the calibrating determinations were made. For more detailed technical data, please write the Orton Foundation.

W.P. DAWSON, INC.
399 THOR PLACE
BREA, CALIFORNIA 92621
(714) 529-2813, (714) 529-2814

OPERATING MANUAL



MODELS LT-3 & LT-3K

CONFIDENTIAL REPRODUCED BY PERMISSION OF THE EDWARD ORTON CERAMIC FOUNDATION

KILN-SITTER OPERATING MANUAL

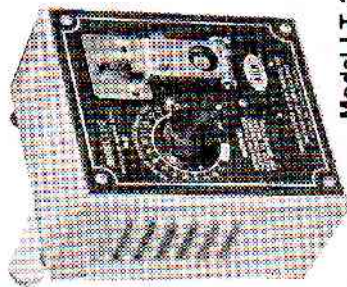

Model LT-3

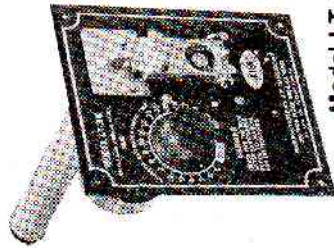

Model LT-3K

CAUTION

The KILN-SITTER® control is a valuable tool to help you achieve consistent results when firing your kiln. It is engineered to give you years of trouble-free performance when it is kept in proper adjustment and maintained as described in the KILN-SITTER® Operating Manual.

The KILN-SITTER® control is **NOT** intended to perform as a fail-safe shut-off device and your kiln should **NOT** be left unattended beyond the estimated firing time. An uncontrollable accident, such as greenware falling against the end of the KILN-SITTER® tube, might cause an over-firing which could damage your kiln. In this event, the operator should be in attendance to shut off the kiln manually.

WARNING

DO NOT FIRE YOUR KILN OVER OR NEAR FLAMMABLE MATERIAL (i.e. wood floor, carpeting, etc.). SEE KILN SITTER Limited Warranty.

Thank you for choosing the KILN SITTER® control on your ceramic kiln. You, like ceramists the world over, can now enjoy your hobby more because the KILN SITTER® is "watching" your kiln while you do other things. Years of trouble free firing are yours to enjoy if you will take the time to read carefully the kiln operating instructions and KILN SITTER® manual.

The KILN SITTER® is a mechanical control that fires your kiln by the TIME and TEMPERATURE method of heat treatment using a small cone or bar. The cone or bar, after being exposed to the proper time and temperature, softens and bends to a pre-determined angle, shutting off the kiln. Your choice of cone or bar, proper KILN-SITTER® adjustment and tube position determine when the kiln will shut off.

The Models LT-3 and LT-3K also have an electrically driven mechanism, set by the operator prior to firing, which will trip the lock and shut off the kiln if the normal cone or bar operation does not perform properly. This back-up device is used only as a safety feature and should not be used to override the function of the cone or bar.

The KILN SITTER® requires very little attention but may need an occasional adjustment check and replacement of critical parts such as the tube assembly, cone supports or sensing rod. Frequency of replacement depends on type of firing, type of clay used, proper venting and moisture content of the pieces being fired.

To insure that your KILN SITTER® is properly adjusted, we suggest you follow the instructions on the following pages and test fire your **empty** kiln with the KILN SITTER® before you do anything else.

KILN SITTER LIMITED WARRANTY

The KILN SITTER is guaranteed to be free of defects in material and workmanship for one (1) full year from date of original purchase. Any part that proves to be defective under normal operating conditions will be replaced when returned prepaid to W.P. Dawson, Inc., 389 Thor Place, Brea, California 92621. Returned part must be accompanied by written proof of purchase and description of defect (and operating problem it caused) within two (2) weeks of occurrence.

This warranty expressly does not extend to the following:

1. Tube assembly and other KILN SITTER parts damaged in an overfiring determined by W.P. Dawson, Inc. not to be a defect in material or workmanship.
2. Damage to the kiln and kiln contents resulting from an overfiring.
3. KILN SITTER parts damaged during salt or reduction firing.
4. Damage to KILN SITTER when operated beyond the listed electrical rating.
5. Damage caused when kiln is installed over or near flammable material.

The liability of W.P. Dawson, Inc. is limited to the purchase price of the KILN SITTER.

KILN-SITTER PARTS IDENTIFICATION

MODEL LT-3

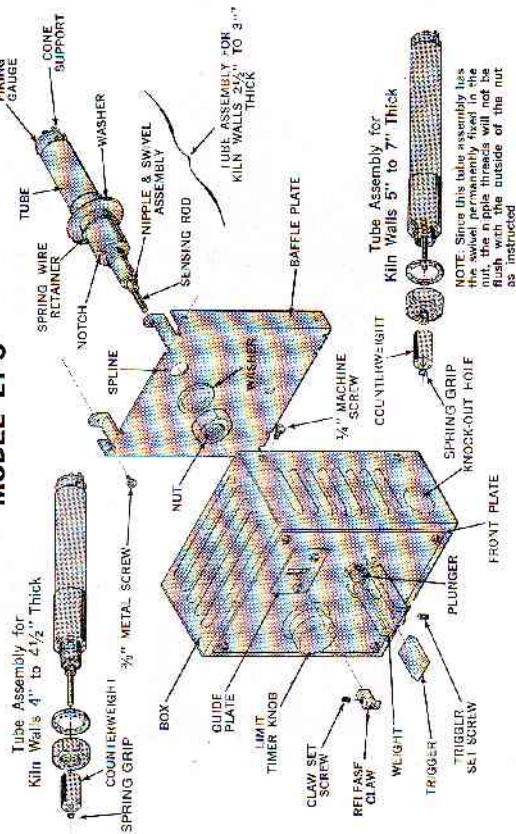

MODEL LT-3K

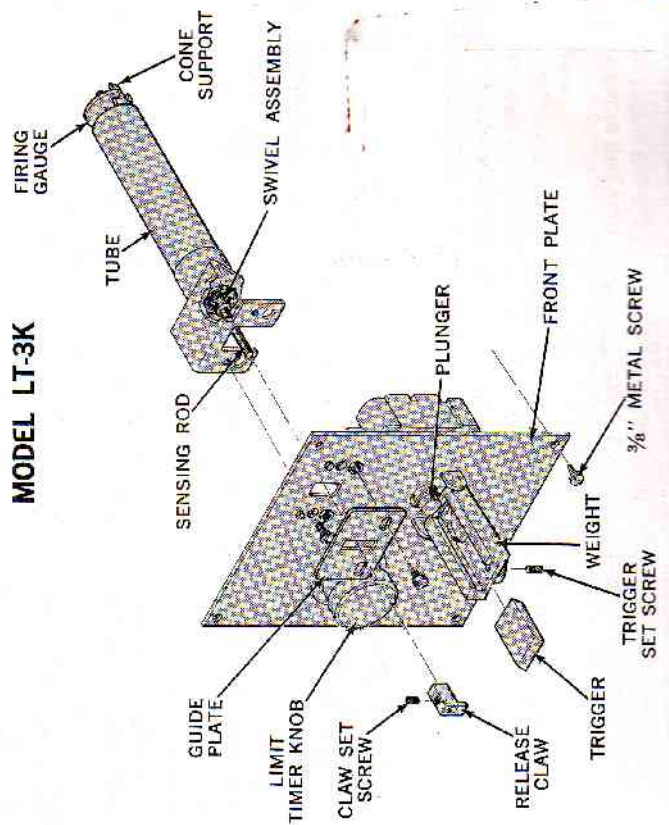

ADJUSTMENTS

Even if your KILN-SITTER® was adjusted at the factory, it could have been jarred out of adjustment during shipment or delivery. Let's first be sure the KILN-SITTER® is in proper adjustment before firing.

Here are some simple adjustment checks for you to make before firing your kiln. We urge you to make them carefully and repeat this check every 30 firings during its lifetime.

1. **TURN ALL SWITCHES OFF**
2. **INSTALL FIRING GAUGE**

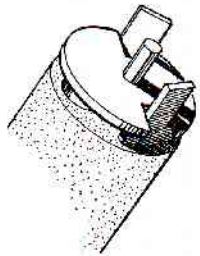

Figure 1

Normally the firing gauge is in position when your kiln is shipped from the factory (held by a rubber band at the end of the KILN-SITTER® tube). If it has been removed, it should now be replaced over the sensing rod and cone supports, as shown in Figure 1.

CAUTION: Remove firing gauge before operating kiln.

3. **CHECK POSITION OF RELEASE CLAW AND WEIGHT TRIGGER**

a. With the firing gauge in position, swing the weight up against the guide plate. Pull the claw forward (against the slight play in the swivel/pivot assembly) and check for a 1/16 inch clearance between the inside lip of the claw and face of the trigger as shown in Figure 2. Set screw on top of claw may be loosened if the adjustment of the claw position is necessary. Retighten set screw firmly.

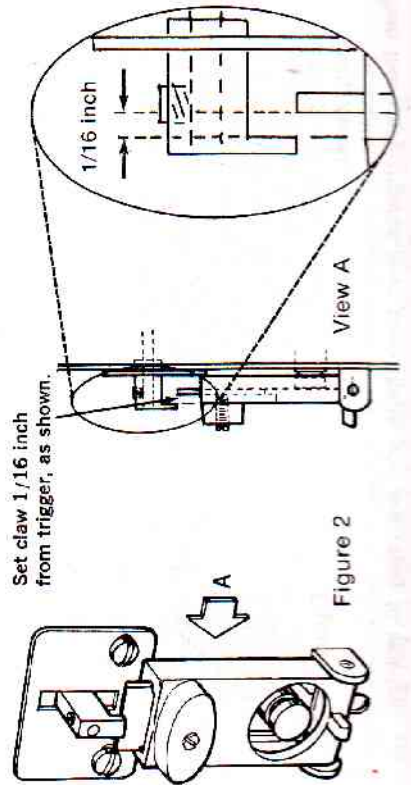
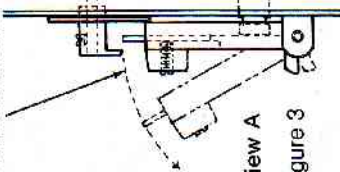

Figure 2

Set trigger to just clear claw, as shown.



View A

Figure 3

b. When weight swings forward, the trigger should just clear the tip of the claw, as shown in Figure 3. The set screw in front of weight may be loosened to raise or lower trigger, as shown in Figure 4. Set screw must be firmly retightened or the force of repeated falling of the weight may cause the trigger to creep out of adjustment.

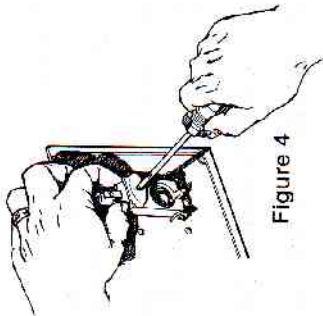

Figure 4

Check your kiln with a level to make sure it is not standing on an uneven floor. If this should occur your weight may not fall when released.

WARNING: Do not fire your kiln over or near **FLAMMABLE** material (i.e. wood floor, carpeting, etc.).

4. CHECK THE TRAVEL OF SENSING ROD

THE FIRING GAUGE SHOULD NOW BE REMOVED BUT KEPT FOR FUTURE PERIODIC ADJUSTMENTS. The sensing rod is now free to travel vertically within the tube cavity. It should travel freely in the center of the cavity without touching the sides at any point, as shown in Figure 5 and 6.

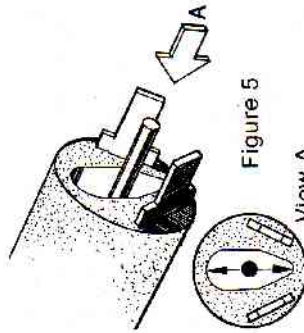

Figure 5

View A

If necessary, the sensing rod may be centered by loosening the two guide plate screws in front of the KILN-SITTER® and moving the guide plate to right or left as required, as shown in Figure 7. Be sure guide plate screws are firmly retightened.

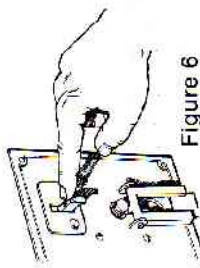

Figure 6

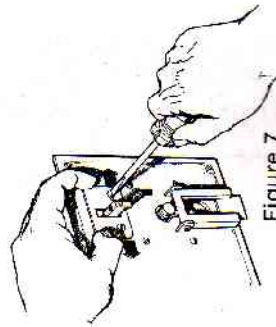

Figure 7

When these adjustments have been made, you are ready to test fire.

TEST FIRING

Firing tests are made with the kiln **empty**. Two small size cones, which mature at a relatively low temperature, are provided with the KILN-SITTER® for test firing. This allows you to complete the test firing in the shortest possible time. Additional cones are available from your dealer.

1. FIRING GAUGE HAS BEEN REMOVED.

2. APPLY KILN WASH.

(A small nail polish bottle with brush is ideal for this purpose.) Mix Hi-Fire Kiln wash with water to a creamy solution. Apply a THIN coat to the cone supports and the sensing rod where they will come in contact with the cone. Do not apply kiln wash to the cone or to the end of the porcelain tube. Allow wash to dry thoroughly.

Do not allow kiln wash to accumulate.

3. RAISE WEIGHT UP AGAINST GUIDE PLATE.

4. PRESS CLAW DOWN LIGHTLY UNTIL IT ENGAGES TRIGGER.

5. INSERT CONE. (See page 7, #7)

While holding claw down over trigger, carefully place one of the test cones flat on the cone supports with the inside edge of the number circle even with the outside edge of the cone support. See Figure 8. Cone should be back against the metal step of the cone support with the center of the cone parallel with the end of the tube.

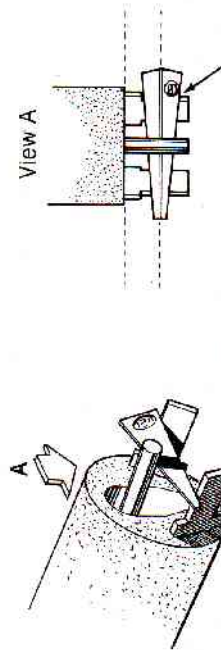

Figure 8

CAUTION: Since the softening and bending of the cone shuts off your kiln, its correct positioning is important for proper firing. IF CONE IS DISLODGED BY ACCIDENT OR ALLOWED TO COME IN CONTACT WITH THE PORCELAIN TUBE, AN OVER-FIRING MAY RESULT WHICH COULD CAUSE SERIOUS DAMAGE TO YOUR KILN.

The cone now holds the claw engaged so that the weight is supported and your hands are free. You are now ready to close the kiln and begin the test fire.

6. TURN ALL KILN SWITCHES OFF.

7. THE LIMIT TIMER IS USED DURING THE TEST FIRING. TURN TIMER KNOB CLOCKWISE TO NUMBER 1½ OR 2 ON THE SCALE.

8. INSERT FINGER INTO THE HOLE IN THE WEIGHT AND PUSH FIRMLY IN ON PLUNGER UNTIL IT LOCKS.

9. FIRE THE KILN BY USING THE REGULAR KILN SWITCHES, AS INSTRUCTED BY THE KILN MANUFACTURER. (For purposes of test firing, when kiln is empty, the highest temperature setting may be used.)

In approximately one hour the KILN-SITTER® weight will drop, shutting off the kiln.

When the kiln is cool enough to handle you may open it and inspect the cone. If all adjustments have been made correctly, the cone on the KILN-SITTER® will be bent to an approximate 90 degree angle, shape similar to the illustration in Figure 9. However, if it is bent similar to the overfired illustration, reduce the kiln switch settings. This will increase the firing time, reduce the rate of climb and allow the cone to mature properly.

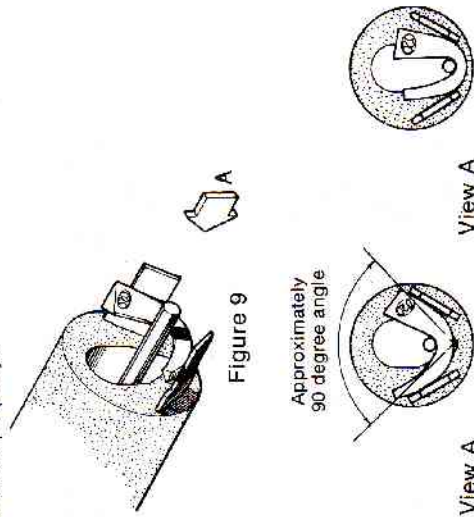

Figure 9

Approximately 90 degree angle

View A

View A

UNDERFIRED
(Incorrectly adjusted)

CORRECT ADJUSTMENT

OVERFIRED
(Incorrectly adjusted)

The best way to verify that your load is reaching a certain firing treatment is by using witness cones. These are valuable and inexpensive instruments which reliably measure actual firing performance. Witness cones are optional but we recommend their use during test firing and also periodically during normal operations, as a check for consistent firing performance. For information on witness cones, refer to page 9.

You are now ready to begin normal firing operations.

NORMAL OPERATION

It is the responsibility of the KILN-SITTER® user to become familiar with the proper operation and adjustment of the KILN-SITTER®, if the simple steps and precautions, outlined in this manual, are followed with care, it will serve you as a valuable and reliable instrument for greater success and enjoyment in your ceramic firing.

When you have assured that the KILN-SITTER® is in proper adjustment by test firing, as described in that section, you are ready for normal firing operation.

1. CHECK SENSING ROD

Before each firing check the sensing rod for free and centered travel. See Figure 10. **In spite of precautions, the swivel/pivot of the tube assembly can become corroded or contaminated and alter the normal shut off.** If the sensing rod moves sluggishly, does not fall freely or you have inconsistent firings, immediately replace the tube assembly. Refer to pages 12 through 14.

2. TURN ALL KILN SWITCHES OFF

The life of the KILN-SITTER® switch will be increased if kiln switches are off before engaging KILN-SITTER®.

3. APPLY KILN WASH

Apply a THIN coat of Hi-Fire kiln wash to the cone supports and sensing rod where they will come in contact with the cone. Allow the kiln wash to dry thoroughly. We suggest two pair of supports be available. This allows you to prepare a clean pair while the other pair is being used in the firing.

4. STACK WARE IN KILN

When loading your kiln, care should be taken to keep the KILN-SITTER® tube, cone supports, and cone or bar visible from above at all times. If tube is covered from view, the cone or bar could accidentally be dislodged from its proper position without being noticed and cause a malfunction of the KILN-SITTER® shut-off. Shelves and ware should be positioned at least an inch above or below the KILN-SITTER® tube so that the normal shut-off function will not be obstructed.

5. RAISE WEIGHT UP AGAINST GUIDE PLATE

6. PRESS CLAW DOWN LIGHTLY UNTIL IT ENGAGES TRIGGER.

7. INSERT CONE (Small size cones or bars are used on KILN-SITTER®)
While holding claw down over trigger, carefully place the cone or bar, selected for your firing, flat on the metal cone supports with the inside edge of the number circle even with the outside edge of the cone supports. See Figure 8. Cone or bar should be against the metal step with the center of the cone or bar parallel with the end of the tube. Consistent placement of the cone or bar in this manner will lead to consistent firing control. The cone or bar now holds the claw engaged so that the weight is supported and your hands are free.

8. CHECK POSITION OF CONE OR BAR

As a last step before closing kiln, always check to see that the cone or bar is in its proper position and free of obstructions. AN IMPROPERLY PLACED CONE OR BAR COULD CAUSE AN OVERFIRING AND DAMAGE YOUR KILN AND WARE.

9. CLOSE KILN

All kiln switches are off at this point.

10. SET LIMIT TIMER KNOB (1/4 to 1/2 hr. beyond firing time)

The timing knob will not allow the plunger assembly to engage when in the OFF position. Always set the timing motor prior to switch engagement (pushing in on plunger).

How to use the Limit Timer

The limit timer is a safety shut-off device to protect your kiln from over-firing in case the KILN-SITTER® fails, through some malfunction, to shut off the kiln when the pyrometric cone or bar has matured. The numbers on the limit timer control knob indicate 20 hours of firing time and if your firing requires a longer period the knob may be reset during firing for this additional time. Since the function of the limit timer is to override the actual firing time it should always be set for a longer period than the estimated firing time. After you have become familiar with the firing of your particular kiln you can set the limit time as low as 1/4 hour longer than the estimated firing time. Until you have reached that degree of familiarity, it is safer to set the limit timer 1/2 hour longer than the estimated firing time.

The limit timer may also be used as a timing device to aid you while you are learning to estimate firing times. For example, if the timer knob is set at 7 before firing and the indicator is on 1 when firing is completed, you know that the elapsed time was 6 hours.

Caution: The timing knob should never be set beyond 20 hours. If the timing motor should be inoperative, such action could jam the switch assembly, possibly causing an overfiring.

11. REMOVE TOP PEEP HOLE PLUG. Venting of the kiln for the entire firing period will add years of life to your KILN-SITTER tube assembly. (On large kilns also remove bottom peep hole plug.)

12. INSERT FINGER INTO HOLE IN THE WEIGHT AND PUSH FIRMLY IN ON THE PLUNGER UNTIL IT LOCKS.

13. WEIGHT CLEARANCE

The area outside the kiln should be clear of obstructions so the free fall of the weight is not impeded.

14. FIRE THE KILN BY USING THE REGULAR KILN SWITCHES, AS INSTRUCTED BY THE KILN MANUFACTURER.

DO NOT LEAVE THE KILN UNATTENDED BEYOND ESTIMATED FIRING TIME. An uncontrollable accident, such as greenware falling against the end of the KILN-SITTER® tube may cause an overfiring which could damage your kiln. Should this occur, the operator should be in attendance to shut off the kiln manually.

WITNESS CONES

A pyrometric cone is a slender pyramid composed of materials compounded in selected combinations to make a cone that will react to time and temperature in the same way as the ware you place in your kiln. Because different clays and glazes require different heat treatment to mature properly, pyrometric cones are made in a series of cone numbers so that one is available to properly control the firing of the clay or glaze you are using.

Even though small cones are always used on the KILN-SITTER®, LARGE SIZE cones are recommended as witness cones for test firing your kiln and KILN-SITTER®, and periodically during normal firing, to help you determine whether firing shut-off is just right ... too soon (too low temperature) ... or too late (too high a temperature). During the test firing you will also learn your kiln's "personality" or its heat distribution.

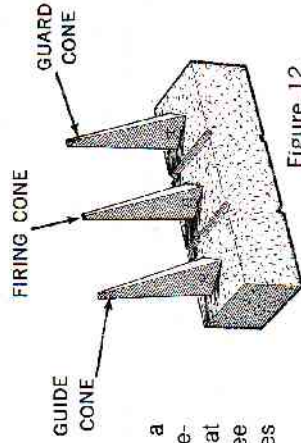

Figure 12

For this test firing you will need a plaque, which is a porous clay base designed to hold three large size cones at an angle of 8 degrees from vertical. See Figure 12. (Note: Self-supporting cones are available.)

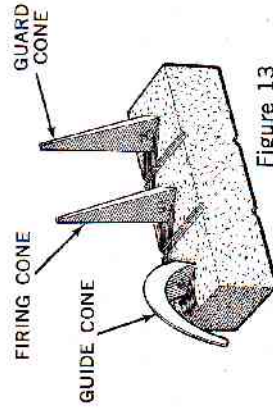

Figure 13

A cone, one number cooler than the firing cone, is placed on one side. This is called the GUIDE CONE. It matures at a temperature approximately 30 degrees lower than the firing cone. When it bends it serves warning that shut-off time is near. See Figure 13.

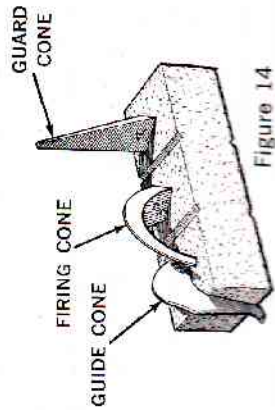

Figure 14

The cone number we wish to fire to is placed in the middle. It is called the FIRING CONE. It is the same cone number as the cone on your KILN-SITTER®. When it bends over with the tip close to, but not quite touching the base, you know that the desired heat treatment has been reached. See Figure 14.

On the other side is a cone, one number hotter than the firing cone. It is called the GUARD CONE. If it bends at all you know that the kiln has fired beyond the preselected point.

The plaque of three cones should be placed on a shelf close to the level of the KILN-SITTER® tube. However, because a shelf supported by stilts is not completely stable, the height of the shelf should be one inch above or one inch below the tube. This will prevent a possible jamming of the normal KILN-SITTER® shut-off function should the shelf expand or tilt in the direction of the tube.

After test firing, during normal operations, you may wish to place a plaque on EACH shelf level, since temperatures vary at different levels with a kiln. When setting your kiln shelves, follow the kiln manufacturer's instructions. The spacing between shelves will depend upon the objects you wish to fire. This spacing, as well as the size and weight of your ware, has an effect on heat distribution.

After firing is completed you will see some differences in the appearance of the test plaques. If for example your firing was made with two or more shelves, the lower shelf will usually show less bending of the cones than the plaque located on a shelf near the top of the kiln. This range of heat treatment normally will be within the range recommended for your materials.

The shelf locations, and amount of material placed on each shelf and the switching sequence will have some effect upon the heat distribution in your kiln. But as long as each plaque of cones show cone values within the range recommended for your material you can be sure it is receiving proper heat treatment.

Now fire the kiln in the manner recommended by the kiln manufacturer. Use the proper switch sequence and note venting procedures for necessary air circulation.

If witness cones, after the first test fire, appear similar to those illustrated in Figure 14, you will know that the KILN-SITTER® is in proper adjustment, but make a second test fire exactly as you did before. This will serve as a double check and indicate consistency of firing performance.

If the witness firing cone is UNBENT, then test fire a second time using a hotter cone on the KILN-SITTER® (one number hotter).

If the witness firing cone is FLAT, then test fire a second time using a cooler cone on the KILN-SITTER® (one number cooler).

If a second test fire, as recommended above, does not cause proper maturing of the witness cones, as illustrated in Figure 14, then it is recommended that you recheck all adjustments, as described in that section and repeat the two test fires.

MAINTENANCE OF YOUR KILN-SITTER

Your KILN-SITTER® is manufactured from the finest materials available—selected for strength, durability and resistance to heat and corrosion. However, during the firing operation, moisture and corrosive gases are created which can, in time, alter the normal shut off function. Below are maintenance procedures and operating recommendations which will keep your KILN-SITTER® doing it's job. Careful attention to these instructions will reward you with trouble free firing.

NEVER USE LUBRICANTS OF ANY KIND ON THE KILN-SITTER®

PERIODIC ADJUSTMENTS

The KILN-SITTER® may get out of adjustment during use and we suggest you repeat an adjustment check every 30 firings as described on Page 3 under Adjustments.

VENTING OF KILN

The top peep hole should be left open for the entire firing period. This venting will reduce deterioration of the kiln's metal parts and increase the life of the tube assembly. (Larger kilns may need both top & bottom plugs removed).

CARE OF CONE SUPPORTS

It is important that excess Kiln Wash not be allowed to accumulate on the supports. We recommend they be cleaned after every firing with a small wire brush. In the event the kiln wash or cone glaze cannot be removed rotate the supports to the clean side or replace them. We suggest two pair of supports be available. This allows you to prepare a clean pair while the other pair is being used in the firing.

• CARE OF THE SWIVEL/PIVOT (Tube assembly)

The swivel/pivot of the tube assembly is the most sensitive part of the KILN-SITTER® and can become corroded and contaminated during normal firing. This can cause sluggish movement of the sensing rod and alter the shut off of the KILN-SITTER®. We recommend, as good insurance against a mishap, that the guide plate be removed and the swivel/pivot of the tube assembly be examined every 6 to 12 months. The frequency of inspection depends on the type of firing, moisture content, clay composition and humidity of the area. Evidence of contamination or sluggish movement would indicate immediate replacement of the tube assembly.

SENSING ROD

Continued operation at high fire temperatures will eventually cause the end of the rod to deteriorate or bend. This will, in turn affect the adjustment of the trigger and claw. If this occurs, the rod must be replaced.

OPERATIONAL TEMPERATURE

The KILN-SITTER® is engineered to withstand kiln temperatures up to and including cone No. 8. Temperatures higher than this limit will reduce the normal lifetime of the cone supports and sensing rod.

REPLACEMENT OF TUBE - MODEL LT-3

Should it become necessary to replace the tube in the Model LT-3 KILN-SITTER®, the following instructions should be followed.

CAUTION: BE SURE POWER IS OFF BEFORE PROCEEDING!

1. Refer to PARTS IDENTIFICATION, Model LT-3, on Page 2 for an exploded illustration of Model LT-3 and the names of its parts.

2. Remove box from baffle plate by unscrewing the ¼" machine screws on the right and left side of the box (4 screws).

3. Remove baffle plate from kiln by unscrewing the four ⅜" metal screws. Baffle plate with tube assembly attached is now free to be withdrawn from opening in the kiln wall.

4. Disassemble the old tube from the baffle plate by removing the large nut and washer.

5. Remove nut and washer from the new tube assembly. Insert nipple and tube through hole in baffle plate, as shown in Figure 15. Replace washer and nut but before tightening be sure that the spigote, protruding from the baffle plate engages in the notch at the top of the tube metal jacket. When the nut is tightened, the end of the nipple threads should be flush with the outer surface of the nut. If necessary, the nipple can be threaded in or out of the jacket to achieve this adjustment. When these things are done, tighten nut firmly.

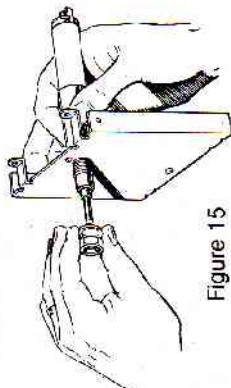

Figure 15

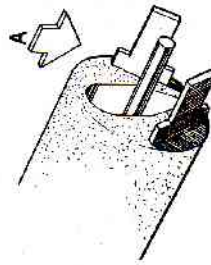
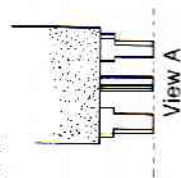

Figure 16

6. As shown in Figure 16, the rear end of the sensing rod should be even with or slightly behind the ends of the cone supports. Set-screw in swivel assembly may be loosened if adjustment is necessary. Be sure set-screw is firmly retightened.



View A

7. Place the spring wire retainer over tube and onto metal jacket, then the washer. After replacing baffle plate onto kiln wall, push washer and spring wire retainer forward against the kiln wall.

8. Counterweights are on all tube assemblies except the 2½", 3" and K-long or short tube assemblies. These weights provide a counterbalance which controls the weight of the Sensing Rod as it bears on the cone during firing. In this way firing performance is equalized between Sensing Rods of different lengths.

The counterweight must be positioned up tight against the swivel nipple, held in place by the sliding spring grip. See Figure 17.

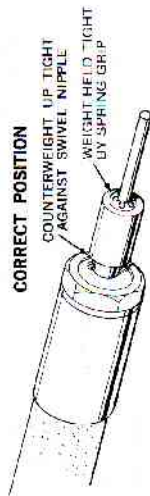
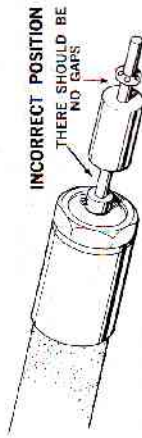

Figure 17



9. Replace box assembly. Adjust and test fire the newly installed tube, as described in the front part of the manual.

REPLACEMENT OF TUBE - MODEL LT-3K

Should it become necessary to replace the tube in the Model LT-3K KILN-SITTER®, the following instructions should be followed.

CAUTION: BE SURE POWER IS OFF BEFORE PROCEEDING!

1. Refer to PARTS IDENTIFICATION, Model LT-3K, on Page 2 for an exploded illustration of Model LT-3K and the names of its parts.
2. The tube is attached to the front plate by two flat headed screws which are hidden behind the metal guide plate. It is, therefore, necessary to first remove the guide plate by removing its two screws.
3. Remove the two flat-headed screws, which were hidden behind the guide plate. This frees the tube from the front plate.
4. Free the front plate from the kiln wiring box by removing its four screws—top and bottom.
5. The plate can now be pulled forward as far as the wiring will allow. Usually this will provide enough room to remove the old tube and install its replacement. If wiring does not provide sufficient clearance for the tube, it may be necessary to remove the entire wiring gutter from the kiln.
6. Attach the new replacement tube. Refer to exploded diagram, inside back cover, for proper positioning of tube.
7. Replace front plate onto the kiln wiring box.
8. Adjust and test fire the newly installed tube as described in the front part of the manual.

KILN-SITTER® PARTS LIST MODELS LT-3 AND LT-3K

Part No.	Description	Part No.	Description
1	Gauge, firing	56	Screw, motor mounting 6/32 x 3/8"
2	Pt. Cone Supports	57	Locking Cam
3	Sensing Rod, (advise model and kiln wall thickness)	58	Spring, locking cam
4	Tube assy. (advise model and kiln wall thickness)	59	Set screw, knob 10/32 x 3/8"
5	Washer	60	Knob only, 9/16" thick
6	Brass Nipple only	61	Motor, Limit Timer (220V/60 Hz/20hr)
6a	Brass Nipple with Swivel (short)	62	Motor, Limit Timer (120V/60 Hz/20hr)
6b	Nipple with Swivel (long)	63	Motor, Limit Timer (220V/50 Hz/20hr)
7	Washer, tube nut	64	Spring Grip
8	Nut only, tube	65	Tube Assembly, Short, K and LT-3K, (measures 6" from end of porcelain to end of bracket)
9	Nut with Swivel, tube	66	Tube Assembly, long, K and LT-3K (measures 7" from end of porcelain to end of bracket)
9a	Nut with Swivel, tube	67	Lock Washer, center post screw
10	Puncher Assembly	68	Screw, center post 6/32 x 5/16"
11	Puncher Assembly, Delta Button	69	Lock Washer, center post screw
12	Claw and Set Screw	70	Center Post
13	Guide Plate only	71	Center Post Assembly (), #24, #25, #17, #12 and #15
14	Set Screw, 6/32 x 3/8"	72	Nut, switch mounting 4/40 radio
15	Set Screw, 6/32 x 3/8"	73	Stand-off Bushing, switch mounting
16	Paper Washer, Center post	74	Screw, flat head 6/32 x 5/16"
17	Spring, center post	75	Screw, switch mounting 4/40 x 1 1/8" oval head
18	Set Screw, 8/32" x 3/8"	76	Shim, motor mounting
19	Pivot Pin	77	Front Plate Assembly, LT-3, 20 hr. with #29, #30, #102, #103 less #16a and #16b
20	Retainer, lock spring	78	Front Plate Assembly, LT-3, 20 hr. with #29, #30, #102, #103 less #16a and #16b
21	Screw, 4/40 x 1/2"	79	Front Plate Assembly, LT-3K, 20 hr. with #29, #30, #102, #103 less #16a and #16b
22	Retainer, locking cam or lock	80	Switch block #94 with contacts and center post spring
23	Screw, 3/8" x #8 metal	81	Switch block with contacts less center post & spring
24	Box, large opening (P-10 & LT-4)	82	Switch block only
25	Heat Baffle, off center hole (P-10 & LT-4)	83	Nylon washer, switch mounting
26	Retainer, spring ring	84	Switch block #94 with contacts
27	Counterweight, tube (P & LT-3) 4"	85	Nylon washer, contact
28	Counterweight, tube (P & LT-3) 4"	86	Nut, contact
29	Counterweight, tube (P & LT-3) 5"	87	Screw, 10/32 x 3/8"
30	Counterweight, tube (P & LT-3) 6"	88	Trigger (1/16" x 3/8" x 1 3/8")
31	Counterweight, tube (P & LT-3) 7"	89	Weight only (1/16" x 3/8" cavity)
32	Bracket, tube	90	Bracket, tube

KILN-SITTER MODEL LT-3

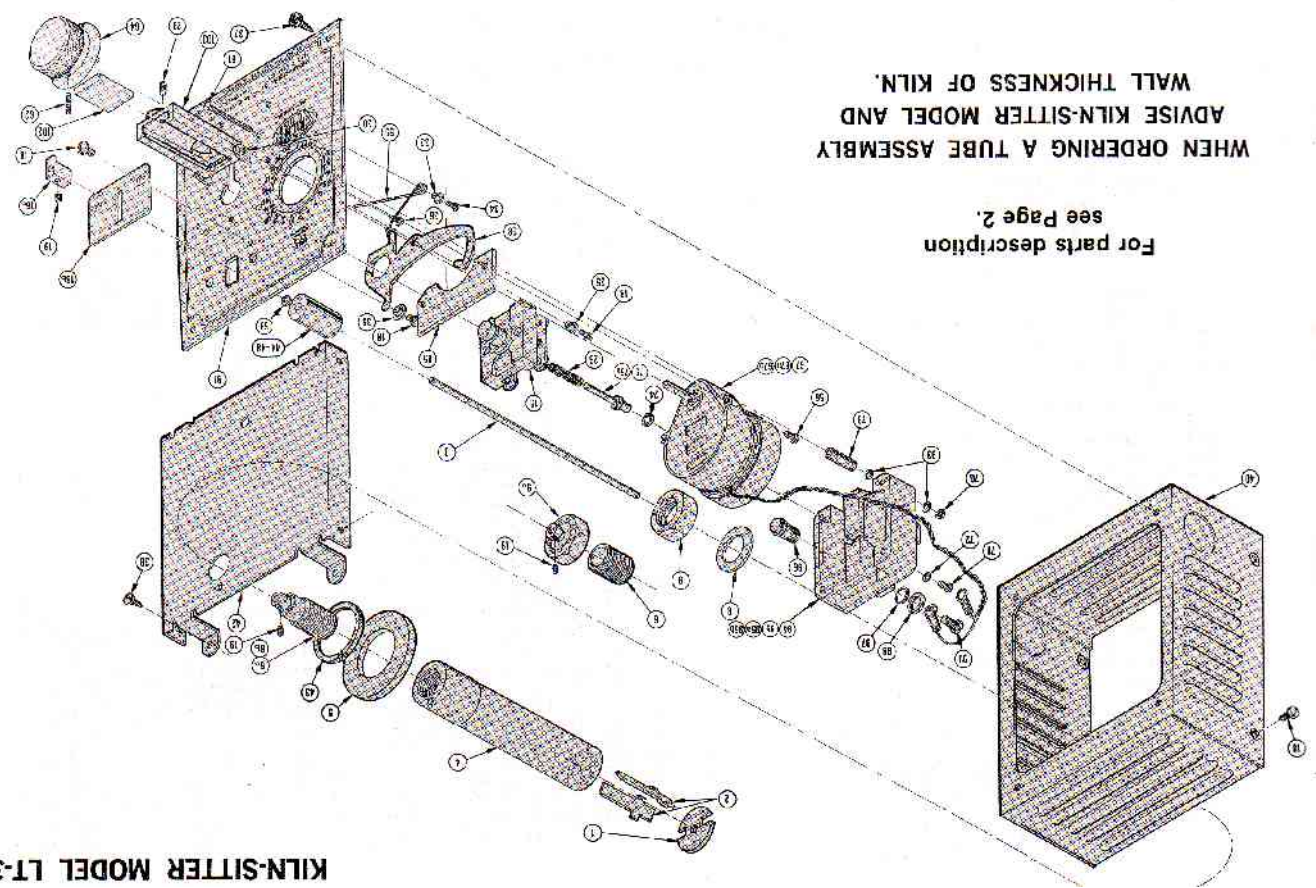

For parts description
see Page 2.

WHEN ORDERING A TUBE ASSEMBLY
ADVISE KILN-SITTER MODEL AND
WALL THICKNESS OF KILN.

KILN-SITTER MODEL LT-3K

WHEN ORDERING A TUBE ASSEMBLY
ADVISE KILN-SITTER MODEL
AND KILN MANUFACTURER.

For parts description
see Page 2.

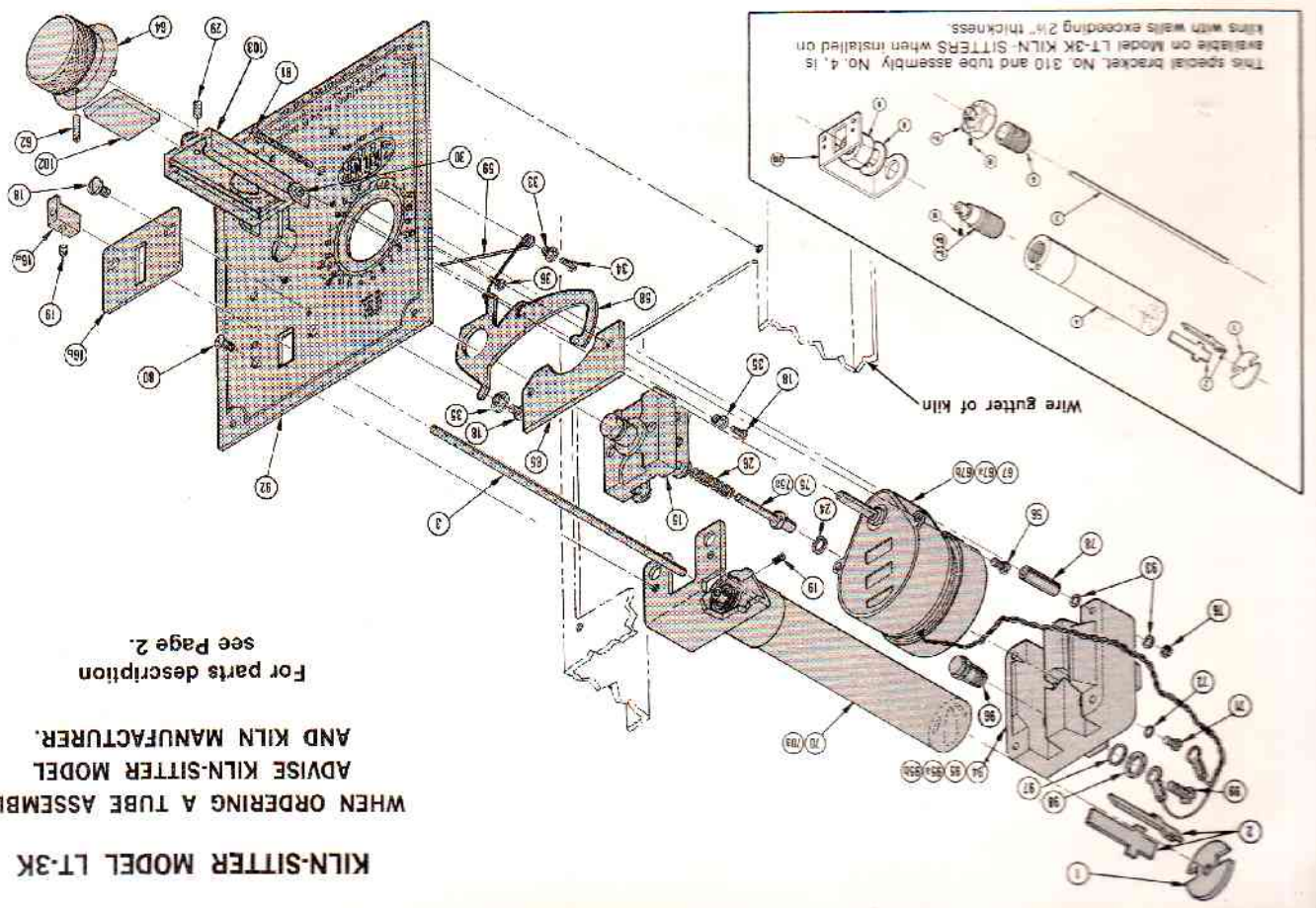

This special bracket, No. 310 and tube assembly, No. 4, is
available on Model LT-3K KILN-SITTERS when installed on
kilns with walls exceeding 2 1/2" thickness.

Wire gutter of kiln